



THE X1

THE BMW X1.



INNOVATION AND TECHNOLOGY.



20 Powertrain and suspension



22 Driver assistance
23 Safety



24 Connectivity and infotainment
25 Comfort and functionality

EQUIPMENT.



26 Models and Lines



32 Additional equipment

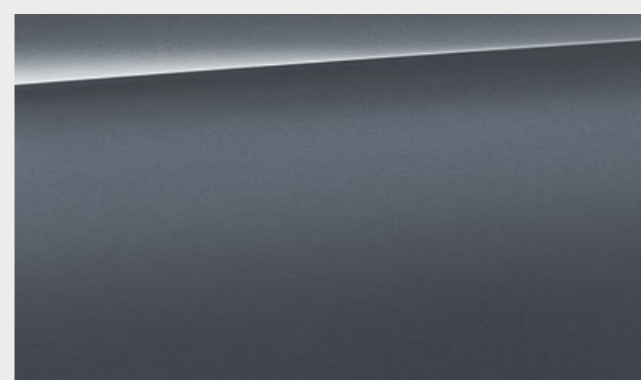

36 Exterior colours

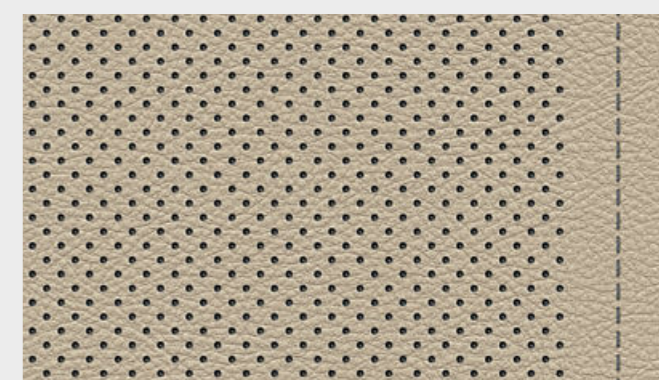

38 Interior colours

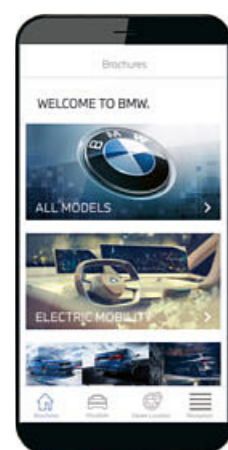

YOUR NEW SPEED DATING APP.

DOWNLOAD NOW THE BMW BROCHURES APP FROM YOUR APP STORE AND DISCOVER DRIVING PLEASURE!



40 Wheels and tyres



41 Original BMW Accessories

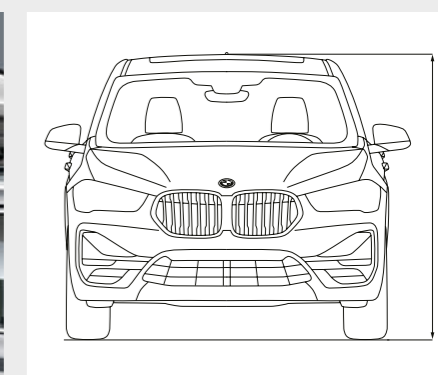

42 Technical data



WILD
LIFE.



A LOT OF LIFE,
A LOT OF STYLE.





**MULTIPLIES
YOUR OPTIONS
BY THE FACTOR X.**



**MAKES
YOU SMILE
FASTER.**





**HERE AND NOW
THERE'S ENOUGH ROOM
FOR A LOT OF WOW.**

**YOUNG, WILD, FAST
LOOKING FOR SUITABLE
COUNTERPART.**



**FULL CHARGE
OF DYNAMISM.**





**LONG DISTANCES? SURE.
CONTINUOUS STARES?
ALWAYS.
BORING? NEVER!
THE BMW X1.**



BMW EFFICIENT DYNAMICS.
LESS EMISSIONS. MORE DRIVING PLEASURE.

■ Standard equipment □ Optional equipment



ENGINE HIGHLIGHTS OF THE BMW X1.

BMW X1 xDrive20i

BMW TwinPower Turbo 4-cylinder petrol engine with 131 kW (178 hp) and 280 Nm torque
Acceleration 0–100 km/h: [7.3] s
Top speed: [223] km/h
Combined fuel consumption: [6.3–6.7] l/100 km
Combined CO₂ emissions: [144–153] g/km

BMW X1 xDrive20d

BMW TwinPower Turbo 4-cylinder diesel engine with 140–120 kW (190–163 hp) and 400 Nm torque
Acceleration 0–100 km/h: [7.8–8.7] s
Top speed: [219–211] km/h
Combined fuel consumption: [5.0–5.3] l/100 km
Combined CO₂ emissions: [131–140] g/km

□ The **adaptive suspension** makes it possible to adjust the damper characteristics to suit the driving situation and optimises ride comfort and driving dynamics.

□ The **M Sports steering** creates direct and agile driving behaviour and less physical effort is required to turn the wheel.

□ The **M Sport suspension** is set 10 mm lower and delivers a more athletic suspension design.

□ The **8-speed Steptronic Sport transmission*** offers incredibly sporty gear changes. Whether automatic or manual using gearshift paddles or gear lever.

□ The powerful **M Sport brake*** features large brake discs and exclusive brake calipers painted in Blue metallic with the M logo.

■ For maximum traction, driving dynamics and safety, the **BMW xDrive all-wheel drive system** provides variable drive power distribution to the front and rear axes.

AERODYNAMICS

■ Targeted aerodynamic changes to the vehicle body such as air vent control, Air Curtain and Air Blades improve its air resistance. The airflow-optimised components contribute not only to reduced fuel consumption, but also reduce the level of noise in the interior.

DRIVING EXPERIENCE CONTROL INCL. ECO PRO

■ The Driving Experience Control* lets the driver choose between the standard COMFORT mode, ECO PRO mode which is geared towards efficiency, and SPORT mode which enables even more dynamic driving. ECO PRO mode adjusts the characteristics of the accelerator, Steptronic transmission and the heating/air conditioning settings to make the drive as fuel-efficient as possible.

BMW EFFICIENT DYNAMICS

■ Get more out of every litre of fuel with BMW EfficientDynamics: better performance, greater efficiency and a heightened driving pleasure. Technical innovations that lower fuel consumption while simultaneously increasing driving pleasure mean that pure dynamics come standard in every BMW.

BRAKE ENERGY REGENERATION

■ With Brake Energy Regeneration, the alternator generates electricity primarily when you brake or take your foot off the accelerator. Previously unused kinetic energy is thereby transformed into electrical energy and fed into the battery.

STEPTRONIC TRANSMISSION

□ The 8-speed Steptronic transmission* ensures particularly smooth gearshifts and outstanding driving comfort, thanks to fast engine speed transitions and tightly spaced gear ratios. It unites superb comfort with impressive dynamics and increased fuel efficiency.

OPTIMUM SHIFT INDICATOR

■ The Optimum Shift Indicator shows the most efficient gear for a given driving situation. In all BMW models, the display informs you of the current gear and gives shifting recommendations. This noticeably lowers fuel consumption through perfectly timed gearshifts, particularly in urban environments and over long distances.



* The availability of some equipment features and functions depends on engine variants or additional options. The market and production availability may vary. You can find detailed information about terms, standard and optional equipment at www.bmw.com or at your BMW Partner.

The official data for fuel consumption and CO₂ emissions were determined in accordance with the measurement processes as defined by European Regulation (EU) 715/2007 in the applicable version. The ranges take into account differences in the selected wheel and tyre size. Figures have been determined on the basis of the new WLTP test cycle and have been converted back into NEDC figures for comparability. Values other than those specified here may apply for the assessment of taxes and other vehicle-related charges that are (also) based on CO₂ emissions.

DRIVER ASSISTANCE.

□ The **safety package Driving Assistant^{1,*}** includes camera-based assistance systems, such as Lane Departure Warning, Collision Warning, High-beam Assistant and Speed Limit Info. The Collision Warning and Pedestrian Warning with light city braking function warns of collisions at speeds between 10 and 60 km/h, while the Lane Departure Warning causes the steering wheel to vibrate as a warning when the lane is unintentionally changed at 70 km/h or over.

□ The **Driving Assistant Plus^{1,*}** equipment provides a clear improvement in safety and comfort. It includes the Collision Warning and Pedestrian Warning with light city braking function, Lane Departure Warning, the High-beam assistant, the speed limit info and the camera-based cruise control with Stop&Go function.

□ The **camera-based cruise control with Stop&Go function^{*}** maintains your preselected speed, as well as the distance to the vehicle ahead. The vehicle takes over accelerating and braking and keeps the predetermined distance to the vehicle ahead even in slow-moving traffic and down to a stand-still in traffic jams.

■ In xDrive models, the **Hill Descent Control^{*}** equipment can be activated to support you on steep downhill routes. The system keeps the vehicle's speed constant without you having to brake, so that you can focus your attention entirely on steering.

□ The **Parking assistant^{2,*}** makes parallel parking easier. The system works by measuring potential spaces while driving past them at a low speed. When a suitable space has been found, the Parking Assistant takes over steering, while you are responsible for selecting the correct gear, as well as pressing the accelerator and brake.

□ The **Rear view camera^{*}** enables improved orientation when reversing at speeds below 15 km/h, for example when parking. It shows the area behind the vehicle on the Control Display. Interactive tracer lines for measuring distance and turning circles assist you when manoeuvring. Obstacles are marked in colour.



SAFETY.

■ Standard equipment □ Optional equipment



□ **Adaptive LED headlights** with low-beam and high-beam headlights include LED turn indicators, adaptive light control and High-beam assistant.

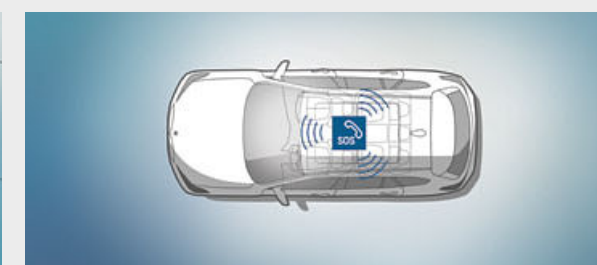

□ Every second counts in case of an emergency. **Intelligent Emergency Call^{*}** reacts automatically if an accident occurs, quickly getting help for you and your passengers.

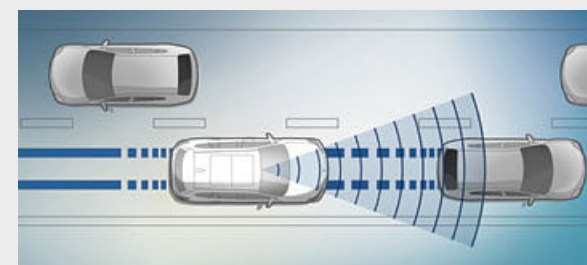

□ **Approach control warning with light city braking function^{*}** notifies drivers of potential collisions and even brakes automatically in emergency situations.

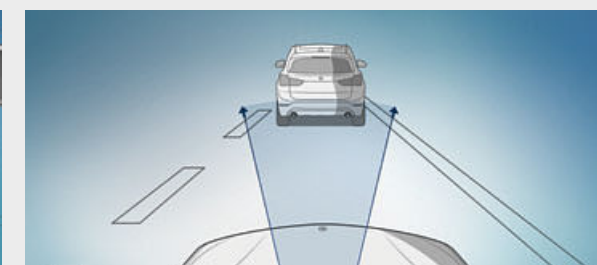

■ **Active Guard** includes front collision warning with braking function and the Speed Limit Assist incl. Speed Limit Info with No-overtaking indicator.

¹ Function may be limited in darkness, fog or bright glare.

² The driver is responsible for constantly monitoring the automated parking procedure in accordance with local road laws.

* The availability of some equipment features and functions depends on engine variants or additional options. The market and production availability may vary. You can find detailed information about terms, standard and optional equipment at www.bmw.com or at your BMW Partner.

Some ConnectedDrive Services may differ between countries. Please consult your local BMW partner for more information.

CONNECTIVITY AND INFOTAINMENT.

BMW ConnectedDrive So connected, you're free.



NAVIGATION PLUS.

Navigation Plus* features a BMW Head-Up Display¹, an iDrive Controller, a built-in 10.25" touch display and an instrument cluster with high-resolution 5.7" TFT display.* The system is operated intuitively using either the iDrive Controller, the direct menu control buttons and six or eight functional bookmarks, voice control or the touchscreen with interactive tiles.

DISPLAY, OPERATING CONCEPT.

In line with the state-of-the-art driver orientation in a BMW, all displays and controls are neatly arranged and within easy reach. They are clearly grouped into the four major categories of driving, comfort, display and operation. This means that new drivers can quickly find their bearings and the amount of time their eyes are diverted from the road is kept to a minimum.

BMW HEAD-UP DISPLAY.

The full-colour BMW Head-Up Display^{1,*} projects information relevant to the journey directly into your field of vision, thereby allowing you to fully concentrate on driving. Information such as the current speed, navigation directions, Speed Limit Info including no-overtaking indicator, along with telephone and entertainment lists are displayed, depending on the equipment.

TELEPHONY WITH WIRELESS CHARGING.

Telephony with wireless charging³ includes a wireless charging dock and an additional USB port. A roof aerial connection improves mobile reception. Two mobile telephones and an audio player can be connected simultaneously via Bluetooth. In addition, there is Bluetooth Office.

PREPARATION FOR APPLE CAR PLAY®.

Why go without the features of your iPhone in your BMW when you can continue operating it as usual? The preparation for Apple CarPlay^{®2} gives you remote access to telephony as well as apps like iMessage, WhatsApp, TuneIn, Spotify and Apple Music. You can also use the voice button on the steering wheel to access Siri, Apple's voice assistant.

TELESERVICES.

Having to remember service appointments is a thing of the past. Thanks to Teleservices*, your BMW automatically knows when routine or unscheduled maintenance is required and sends all relevant data to your BMW service partner. You will then be contacted promptly so that an appointment can be arranged.

¹ The information in the BMW Head-Up Display is not fully visible when viewed through polarised sunglasses. Content shown will depend on the equipment options chosen. Further optional equipment is required to display specific items.

² Apple CarPlay® compatibility and supported functions depend on the model year and the software installed on the iPhone®. When the Apple CarPlay® preparation is in use, selected vehicle data is transferred to the phone. The mobile phone manufacturer is responsible for any further processing of the data.

³ Supports inductive charging for Qi-compatible mobile phones. Special charging cases are available from Original BMW Accessories for selected smartphones that do not support the Qi standard for inductive charging.

COMFORT AND FUNCTIONALITY.

■ Standard equipment □ Optional equipment

Automatic tailgate operation allows convenient opening and closing of the tailgate – simply press the button in the door trim panel on the driver's side or on the vehicle key. The tailgate can also be opened in the conventional manner, using the outside handle, and closed pressing a button on the inside of the tailgate.

The Comfort access system allows passengers to enter the vehicle via the front doors and to open the tailgate without having to actively use the key. The key must simply be nearby, in the driver's trouser pocket for example. To unlock the doors, it is only necessary to touch the handles or the tailgate button.

When open, the Panorama glass roof provides a great deal of fresh air. Closed, it creates a bright, light-flooded atmosphere in the interior. It opens and closes completely automatically at the push of a button, or remotely, and is equipped with slide and lift functions, roller sunblind and wind deflector.

Options for using the boot space are particularly flexible thanks to the numerous ways in which the rear seats can be adjusted to either increase leg room for the rear passengers or maximise loading space in the luggage compartment, whichever has priority. The 60:40 splitting rear seat can be slid forward or back by up to 130 mm. The rear seat backrest can even be folded down in a 40:20:40 split.

The Automatic air conditioning with 2-zone control and automatic target temperature control features separate controls for you and your front passenger. It also includes automatic air recirculation control, a micro active carbon filter, a condensation and solar sensor, as well as rear air vents.

The atmospheric Lights package* contains various LED lights and yields an ambience of pure quality in the interior. The six selectable light designs light up the interior with a stylish combination of direct and indirect lights. Additionally, you are greeted with an impressive welcome display of the exterior LEDs incl. "X1" LED projection.



*The availability of some equipment features and functions depends on engine variants or additional options. The market and production availability may vary. You can find detailed information about terms, standard and optional equipment at www.bmw.com or at your BMW Partner.

Some ConnectedDrive Services may differ between countries. Please consult your local BMW partner for more information.

BASE.

Discover even more with the new BMW Brochures app. Available now, for your smartphone and tablet.

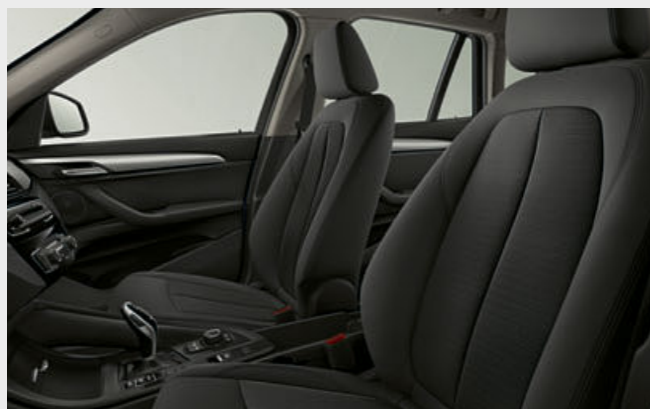

■ The standard steering wheel in three-spoke design features a steering wheel rim made of black leather and has a diameter of 375 millimetres.

■ The seat height and backrest angle of the Standard seat for the driver and front passenger, along with the fore-and-aft position and headrest height, can be manually adjusted.

Selected base model equipment features:

- 17" light alloy wheels V-spoke style 560
- Standard seat for driver and front passenger in Cloth 'Grid'
- Interior trim finishers Oxide Silver dark matt with highlight trim finisher Black high-gloss
- Halogen headlights with daytime running lights in LED technology
- Leather steering wheel
- Driving Experience Control incl. ECO PRO
- Performance Control
- Air conditioning
- Rain sensor
- AM/FM radio with 6.5" Control Display and six loudspeakers



■ 17" light alloy wheels V-spoke style 560 Reflex Silver, wheel size 7.5J x 17 with 225/55 R17 tyres.



□ 19" light alloy wheels Y-spoke style 580 Bicolour Orbit Grey, gloss-lathed, 8J x 19 with 225/45 R19 tyres.

xLINE.

Equipment 26 | 27

■ Standard equipment □ Optional equipment

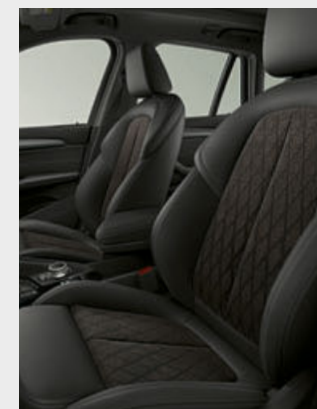

■ The black Sport leather steering wheel with three spokes features a Chrome decorative trim. A thick rim and contoured thumb rests provide an exceptionally pleasant, high-grip feel. The gear lever also comes in leather.

□ The Sport seats for driver and front passenger offer optimum support through higher seat and backrest bolsters and they can be adjusted variably.

■ 18" light alloy wheels Y-spoke style 579 Bicolour Orbit Grey, gloss-lathed, wheel size 7.5J x 18 with 225/50 R18 tyres.

xLine exterior equipment:

- BMW kidney grille with exclusively designed vertical slats with front sides in Aluminium matt, grille frame in Chrome high-gloss
- Front bumper with sump guard and other design elements in Silver matt
- 18" light alloy wheels Y-spoke style 579; other wheels available
- Side skirt trim in Silver matt
- Sump guard in the back with main part in body colour and inset trim painted Silver

xLine interior equipment:

- Door sill finishers, front with Aluminium finishers and "BMW" designation
- Seats in Cloth-/leather combination 'Cross Track' in Granite Brown with Black accent, alternatively Leather 'Dakota' with perforations; other upholsteries available
- Sport leather steering wheel
- Vehicle key with Pearl Chrome detailing
- Accent stitchings depending on the upholstery; in Silver, Grey and Brown on the centre console and the instrument panel
- Interior trim finishers in 'Pearl' dark with accent in Pearl Chrome; other trims available
- Exclusive LED optical fibre in the door trims with six selectable light designs
- Loading sill trim in stainless steel

SPORT LINE.

Discover even more with the new BMW Brochures app. Available now, for your smartphone and tablet.



M Leather steering wheel including multifunction buttons, steering wheel rim in leather 'Walknappa' Black with contoured thumb rests.

■ The Sport seats for driver and front passenger offer optimum support through higher seat and backrest bolsters and they can be adjusted variably.

■ 18" light alloy wheels Double-spoke style 578 Jet Black, wheel size 7.5J x 18 with 225/50 R18 tyres.

■ 18" light alloy wheels Y-spoke style 566 Ferric Grey, gloss-lathed, wheel size 7.5J x 18 with 225/50 R18 tyres.

Sport Line exterior equipment:

- BMW kidney grille with exclusively designed vertical slats in Black high-gloss, grille frame in Chrome high-gloss
- Front bumper with specific design elements in Black high-gloss, Sump guard in body colour
- LED fog lights
- 18" light alloy wheels Double-spoke style 568; other wheels available
- Mirror caps in body colour, alternatively in Black high-gloss
- Side skirt trim in body colour
- Sump guard in the back with main part in body colour and inset trim in black high-gloss

Sport Line interior equipment:

- Door sill finishers, front with Aluminium finishers and "BMW" designation
- Sport seats in Cloth/Sensatec combination Anthracite with Grey highlight; other upholsteries available
- Sport leather steering wheel
- Vehicle key with Pearl Chrome detailing
- Accent stitchings depending on the upholstery; in Silver, Grey and Brown on the centre console and the instrument panel
- Interior trim finishers black high-gloss, other trims available
- Exclusive LED optical fibre in the door trims with six selectable light designs
- Loading sill trim in stainless steel

M SPORT PACKAGE.

Equipment 28 | 29

■ Standard equipment □ Optional equipment

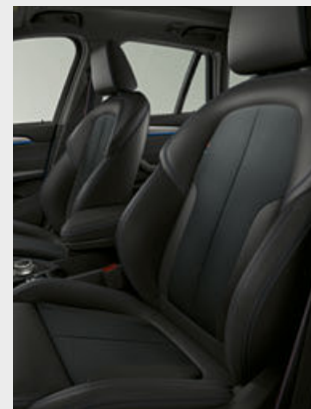

■ M Leather steering wheel including multifunction buttons, steering wheel rim in leather 'Walknappa' Black with contoured thumb rests.

■ The Sport seats for driver and front passenger offer optimum support through higher seat and backrest bolsters and they can be adjusted variably.

■ 18" M light alloy wheels Double-spoke style 570 M Ferric Grey, wheel size 7.5J x 18 with 225/50 R18 tyres.

□ 19" M light alloy wheels Double-spoke style 816 M Bicolour Orbit Grey, gloss-lathed, wheel size 8J x 19 with 225/45 R19 tyres.

M Sport package exterior equipment:

- M Aerodynamics package with front apron, side sills, wheel arch trim and cladding in body colour, rear apron with diffuser insert in Dark Shadow metallic
- BMW kidney grille with exclusively designed longitudinal struts with end faces in Black high-gloss, grille frame in Chrome high-gloss
- LED fog lights
- 18" M light alloy wheels Double-spoke style 570 M; other wheels available
- M Sport suspension, lowered, alternatively standard suspension
- M high-gloss Shadow Line
- M designation on the sides
- Alpine White solid paint; other paintwork available
- M roof rails high-gloss Shadow Line

M Sport package interior equipment:

- M entry sills and M driver footrest
- Floor mats in M design
- Sport seats for driver and front passenger in cloth 'Micro Hexagon'/ Sensatec Black or Anthracite Cloth/Sensatec with Grey highlights; other upholsteries available
- M leather steering wheel
- Vehicle key with exclusive M designation*
- M anthracite headliner
- M interior trim finishers Aluminium Hexagon with highlight trim finishers in Estoril Blue matt; other trims available
- Gear lever with M designation
- Exclusive LED optical fibre in the door trims with six selectable lighting designs
- Stainless steel loading edge trim

*The availability of some equipment features and functions depends on engine variants or additional options. The market and production availability may vary. You can find detailed information about terms, standard and optional equipment at www.bmw.com or at your BMW Partner.

THE BMW X1 xDRIVE25e.

WITH EFFICIENT PLUG-IN HYBRID DRIVE.

The most intelligent way to drive a plug-in hybrid: The BMW X1 xDrive25e combines an efficient BMW TwinPower Turbo engine with a powerful eDrive motor into a hybrid-specific all-wheel drive. The interaction of the two engines guarantees that you can master every challenge with ease. Without lag, the electric motor converts its power into propulsion and impressively supports the petrol engine at every acceleration, or even drives the BMW X1 xDrive25e purely electrically and free of local emissions up to 135 km/h. The hybrid-specific all-wheel drive also optimises traction on slippery surfaces. You can conveniently check whether the charge level is sufficient for purely electric route guidance using BMW Connected eDrive Services. And if not, just keep going in hybrid mode.



The port for external charging of the high-voltage battery is located behind a flap on the vehicle's front side panel on the left.



19" M light alloy wheels Double-spoke style 816 M Bicolour Orbit Grey, gloss-lathed, wheel size 8J x 19 with 225/45 R19 tyres.



The model lettering is on the right side of the tailgate.



With the driving mode button in the centre console, the AUTO eDrive, MAX eDrive and SAVE BATTERY driving modes can be selected intuitively. At the touch of a button, the driver can quickly adjust the plug-in hybrid drive to different driving situations.

ADDITIONAL EQUIPMENT.

Discover even more with the new BMW Brochures app. Available now, for your smartphone and tablet.

■ Standard equipment □ Optional equipment



□ The black Sport leather steering wheel with three spokes features a Chrome decorative trim. A thick rim and contoured thumb rests provide an exceptionally pleasant, high-grip feel. The gear lever also comes in leather.



□ The Luggage-compartment separating net² can be attached behind the rear seats to prevent objects falling forwards into the passenger area (during hard braking, for example). When the rear seats are folded down, it can also be attached behind the front seats.



□ When open, the Panorama glass roof provides a great deal of fresh air. Closed, it creates a bright, light-flooded atmosphere in the interior. It opens and closes completely automatically at the push of a button, or remotely, and is equipped with slide and lift functions, roller sunblind and wind deflector.



□ The full-colour BMW Head-Up Display^{1,*} projects information relevant to the journey directly into your field of vision, thereby allowing you to fully concentrate on driving. Information such as the current speed, navigation directions, Speed Limit Info including no-overtaking indicator, along with telephone and entertainment lists are displayed, depending on the equipment.



□ The 7-speed Steptronic transmission with double clutch technology* combines the best efficiency with particularly smooth gearshifts and outstanding driving comfort, thanks to tightly spaced gear ratios and fast engine speed transitions. It therefore unites superb comfort with impressive dynamics and increased fuel efficiency.



□ The Sport seats for driver and front passenger are characterised by seat and backrest bolsters that are larger than those on the standard seats and, together with adjustable thigh support, for excellent ergonomics and better lateral support during fast cornering. In addition to the seat depth (mechanical), the backrest width (electric) can also be adjusted on the driver's seat.



□ The adaptive LED headlights* include low-beam and anti-dazzle high-beam headlights (BMW Selective Beam) and turn indicators with LED technology. The equipment also features cornering lights, daytime running lights and adaptive light control for an illumination of the road adapted to the driving situation.



□ The two-part Rear lights with LED technology* in characteristic L design consist of one lighting segment in the body of the vehicle and one in the tailgate. Thanks to the dynamic brake light function, the drivers of vehicles behind are warned by flashing brake lights should the vehicle brake hard in a hazardous situation.



■ The Rain sensor including automatic headlight activation automatically activates the windscreen wipers and the low-beam headlights.



□ Child seat ISOFIX attachment: for mounting an ISOFIX child seat to the front passenger seat. The attachment latch is concealed in the seating frame.

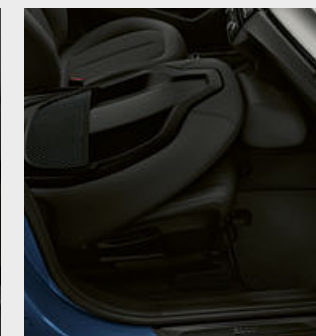

□ The passenger-seat with foldable backrest increases flexibility when loading longer objects.



□ When not in use, the removable ball head of the trailer tow hitch has no negative impact on the sporty appearance of the rear.

¹ The information in the BMW Head-Up Display is not fully visible when viewed through polarised sunglasses. Content shown will depend on the equipment options chosen. Further optional equipment is required to display specific items.

² Available as optional equipment.

* The availability of some equipment features and functions depends on engine variants or additional options. The market and production availability may vary. You can find detailed information about terms, standard and optional equipment at www.bmw.com or at your BMW Partner.

ADDITIONAL EQUIPMENT.

Discover even more with the new BMW Brochures app. Available now, for your smartphone and tablet.

■ Standard equipment □ Optional equipment



□ The HiFi loudspeaker system Harman Kardon, with twelve speakers optimally designed to suit the interior's sound characteristics, guarantees an exceptional music experience. Tweeters and subwoofers deliver a brilliant, powerful range of sound. Elegant aluminium loudspeaker fronts feature "Harman/Kardon" lettering for a high-class look.



□ Navigation Plus* features a BMW Head-Up Display¹, an iDrive Controller, a built-in 10.25" touch display and an instrument cluster with high-resolution 5.7" TFT display. The system is operated intuitively using either the iDrive Controller, the direct menu control buttons and six or eight functional bookmarks, voice control or the touchscreen with interactive tiles.



□ The interior mirror and driver-side exterior mirror feature the automatic anti-dazzle function. Additionally, the driver-side exterior mirror features the automatic curb parking function when the vehicle is put in reverse. Both exterior mirrors are equipped with an electric folding function, as well as a mirror memory function. That makes parking easier and helps to avoid damage to the vehicle.



□ The atmospheric Lights package contains various LED lights and yields an ambience of pure quality in the interior. The six selectable light designs light up the interior with a stylish combination of direct and indirect lights. Additionally, you are greeted with an impressive welcome display of the exterior LEDs incl. "X1" LED projection.



□ Depending on the equipment, Multifunction for steering wheel can be used to operate the telephone, voice control and audio functions via the buttons on the steering wheel. The Manual Speed Limiter is also integrated. It can be used to set an upper limit of 50 km/h for city driving, for example.

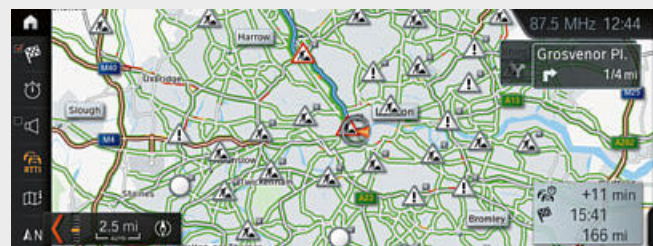

□ Why waste time in traffic jams? Real Time Traffic Information* lets you reach your destination faster and more effectively. It monitors the current traffic situation virtually in real-time and calculates alternative routes. The local hazard warning system is an additional feature that alerts you to adverse road conditions or accidents.



□ The Steering-wheel heating* quickly warms up the rim of the steering wheel at the push of a button, which is especially comfortable in winter.



□ The electric seat adjustment is easy to use and the memory function allows users to save their preferred settings for the seat and exterior mirrors.



□ The Driving Assistant Plus⁴* equipment provides a clear improvement in safety and comfort. It includes the Collision Warning and Pedestrian Warning with light city braking function, Lane Departure Warning, the High-beam assistant, the speed limit info and the camera-based cruise control with Stop&Go function.



□ Telephony with wireless charging² includes a wireless charging dock and an additional USB port. A roof aerial connection improves mobile reception. Two mobile telephones and an audio player can be connected simultaneously via Bluetooth. In addition, there is Bluetooth Office.

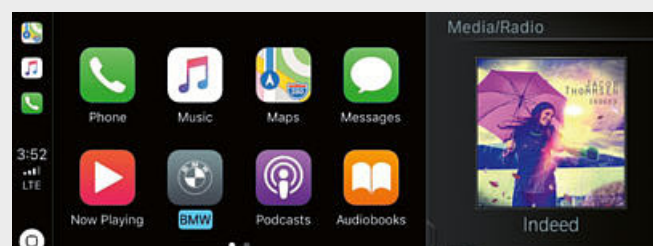

□ Why go without the features of your iPhone in your BMW when you can continue operating it as usual? The preparation for Apple CarPlay³* gives you remote access to telephony as well as apps like iMessage, WhatsApp, TuneIn, Spotify and Apple Music. You can also use the voice button on the steering wheel to access Siri, Apple's voice assistant.



□ Front and rear Park Distance Control (PDC)* makes parking and manoeuvring in tight spaces much easier. The proximity of obstacles is signalled acoustically through a warning sound, and the remaining distance is shown in the Control Display.



□ The Rear view camera* enables improved orientation when reversing at speeds below 15 km/h, for example when parking. It shows the area behind the vehicle on the Control Display. Interactive tracer lines for measuring distance and turning circles assist you when manoeuvring. Obstacles are marked in colour.

¹ The information in the BMW Head-Up Display is not fully visible when viewed through polarised sunglasses. Content shown will depend on the equipment options chosen. Further optional equipment is required to display specific items.

² Supports inductive charging for Qi-compatible mobile phones. Special charging cases are available from Original BMW Accessories for selected smartphones that do not support the Qi standard for inductive charging.

³ Apple CarPlay[®] compatibility and supported functions depend on the model year and the software installed on the iPhone[®]. When the Apple CarPlay[®] preparation is in use, selected vehicle data is transferred to the phone. The mobile phone manufacturer is responsible for any further processing of the data.

⁴ Function may be limited in darkness, fog or bright glare.

* The availability of some equipment features and functions depends on engine variants or additional options. The market and production availability may vary. You can find detailed information about terms, standard and optional equipment at www.bmw.com or at your BMW Partner.

Some ConnectedDrive Services may differ between countries. Please consult your local BMW partner for more information.

EXTERIOR COLOURS.

Discover even more with the new BMW Brochures app. Available now, for your smartphone and tablet.

■ Standard equipment □ Optional equipment



□ Non-metallic 300 Alpine White¹

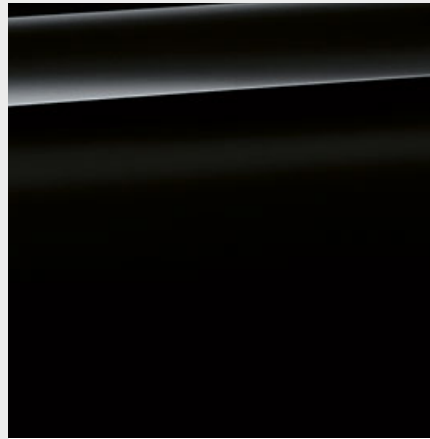

■ Non-metallic 668 Black



□ Metallic A96 Mineral White²



□ Metallic A83 Glacier Silver

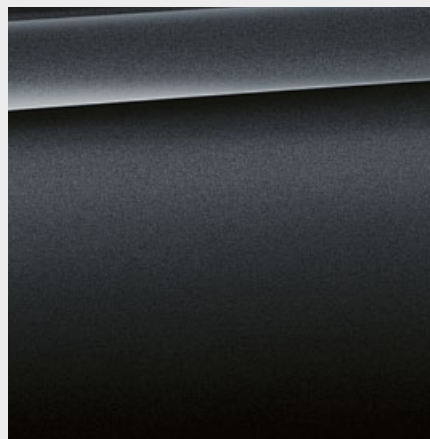

□ Metallic B39 Mineral Grey²

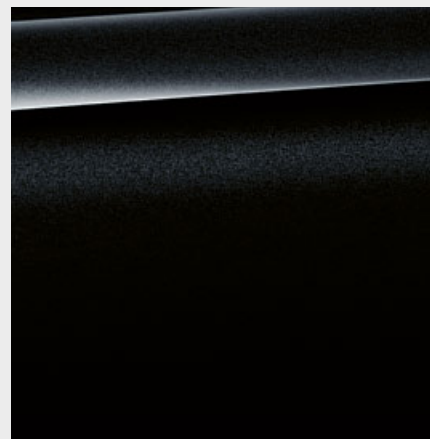

□ Metallic 475 Black Sapphire²



□ Metallic A72 Cashmere Silver



□ Metallic B53 Sparkling Brown

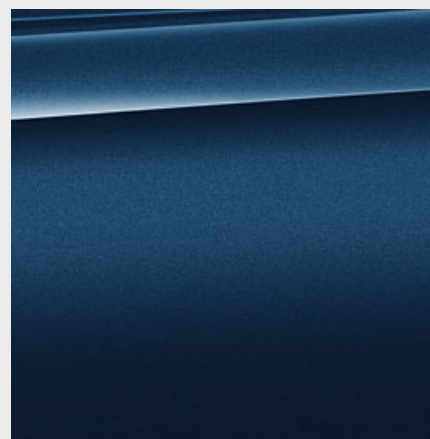

□ Metallic C1M Phytionic Blue

M SPORT PACKAGE



□ Metallic C1X Sunset Orange



□ Metallic C1D M Misano Blue metallic³

BMW INDIVIDUAL



□ BMW Individual C3N Storm Bay metallic²

[Colour samples] These colour samples are intended as an initial guide to the colours and materials available for your BMW. However, experience has shown that printed versions of paint, upholstery and interior trim colours cannot in all cases faithfully reproduce the

appearance of the original colour. Please discuss your preferred colour choices with your BMW partner or in your dealership. There you can also see original samples and be assisted with special requests.

¹ Standard for M Sport package.

² Also optionally available for the M Sport package.

³ Exclusively available for the M Sport package.

The availability of some equipment features and functions depends on engine variants or additional options. The market and production availability may vary. You can find detailed information about terms, standard and optional equipment at www.bmw.com or at your BMW Partner.

INTERIOR COLOURS.

Discover even more with the new BMW Brochures app. Available now, for your smartphone and tablet.

■ Standard equipment □ Optional equipment



CLOTH

Available with

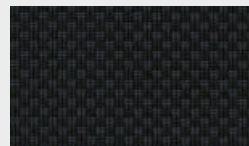

■ Base

Cloth 'Grid'
EGAT Anthracite*

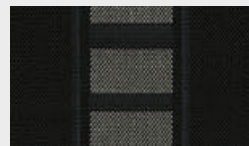

□ Base

Cloth 'Race'
ERL1 Anthracite/
Grey highlight*

SENSATEC

Available with

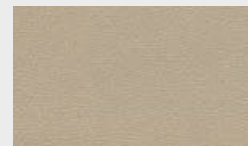

□ Base
■ xLine
■ Sport Line

Sensatec
KCCX Oyster

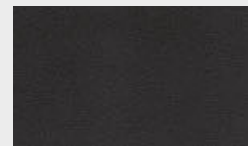

□ Base
■ xLine
■ Sport Line
□ M Sport package

Sensatec
KCSW Black*

LEATHER

Available with



□ xLine
□ Sport Line
□ M Sport package

Leather 'Dakota'
PDOA with
perforations Oyster
and Grey highlight

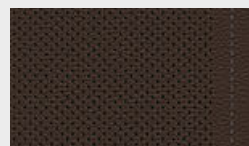

□ xLine
□ Sport Line
□ M Sport package

Leather 'Dakota'
PDMZ with
perforations Mocha

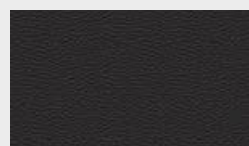

□ Base

Leather 'Dakota'
LCSW Black*



□ xLine
□ Sport Line
□ M Sport package

Leather 'Dakota'
PDSW with
perforations Black

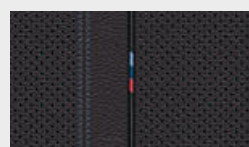

□ M Sport package

Leather 'Dakota'
PDN4 with
perforations Black,
Blue highlight

CLOTH-SENSATEC COMBINATION

Available with

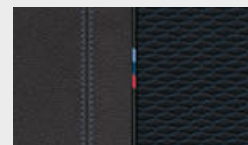

■ M Sport package

Cloth 'Micro
Hexagon' HKSW
Sensatec Black

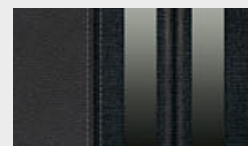

□ Base
■ Sport Line
□ M Sport package

Cloth/Sensatec
combination KFL1
Anthracite, accent
Grey*

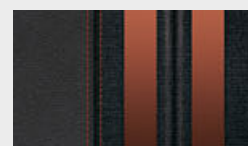

■ Sport Line

Cloth/Sensatec
combination KFIX
Anthracite, accent
Orange

CLOTH/LEATHER COMBINATION

Available with



■ xLine

Cloth-/leather
combination 'Cross
Track' CWG4
Granite Brown/Black

INTERIOR TRIM FINISHERS

Available with

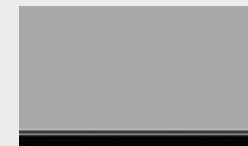

■ Base

Interior trim finishers
Oxide Silver dark
matt with highlight
trim finisher Black
high-gloss

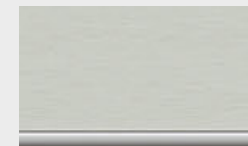

□ Base
□ xLine
□ Sport Line
■ M Sport package

Interior trim finishers
Aluminium, finely
brushed lengthwise
with highlight trim
finishers Pearl
Chrome



■ M Sport package

M interior trim
finishers Aluminium
Hexagon with
highlight trim finisher
Estoril Blue matt

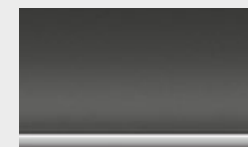

■ xLine

Interior trim finishers
'Pearl' dark with
highlight trim finisher
Pearl Chrome

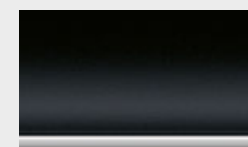

□ Base
■ xLine
■ Sport Line
■ M Sport package

Interior trim finishers
black high-gloss
with highlight trim
finisher Pearl
Chrome



□ Base
□ xLine
□ Sport Line
□ M Sport package

Interior trim
designed in fine-
wood trim 'Fineline'
Stream with accent
in Pearl Chrome



□ xLine
□ Sport Line
□ M Sport package

Interior trim finishers
in fine-wood trim
oak grain matt with
highlight trim finisher
Pearl Chrome

Please note that even normal long- or short-term use can lead to unrecoverable upholstery damage. This can be caused in particular by non-colourfast clothing. Please note that the interior colour depends on the selected upholstery colour.

*The availability of some equipment features and functions depends on engine variants or additional options. The market and production availability may vary. You can find detailed information about terms, standard and optional equipment at www.bmw.com or at your BMW Partner.

WHEELS AND TYRES.

Discover even more with the new BMW Brochures app. Available now, for your smartphone and tablet.



□ 17" light alloy wheels Double-spoke style 564 Reflex Silver with runflat tyres, wheel size 7.5J x 17 with 225/55 R17 tyres.



■ 18" light alloy wheels Y-spoke style 579 Bicolour Orbit Grey, gloss-lathed, wheel size 7.5J x 18 with 225/50 R18 tyres.¹



□ 18" light alloy wheels Double-spoke style 578 Jet Black, wheel size 7.5J x 18 with 225/50 R18 tyres.



□ 18" M light alloy wheels Double-spoke style 570 M Ferric Grey with run-flat tyres, wheel size 7.5J x 18 with 225/50 R18 tyres.



□ 19" light alloy wheels Y-spoke style 511 Orbit Grey, gloss-lathed, wheel size 8J x 19 with 225/45 R19 tyres.



□ 19" light alloy wheels Y-spoke style 580 Bicolour Orbit Grey, gloss-lathed, 8J x 19 with 225/45 R19 tyres.



□ 19" M light alloy wheels Double-spoke style 816 M Bicolour Orbit Grey, gloss-lathed, wheel size 8J x 19 with 225/45 R19 tyres.²



□ 19" M aerodynamic wheels 919 M Bicolour Gunmetal Grey, gloss-lathed, wheel size 8J x 19 with 225/45 R19 tyres.²

¹ Only available in conjunction with xLine.
² Only available in conjunction with M Sport package.

The availability of some equipment features and functions depends on engine variants or additional options. The market and production availability may vary. You can find detailed information about terms, standard and optional equipment at www.bmw.com or at your BMW Partner.

ORIGINAL BMW ACCESSORIES.

Equipment 40 | 41

■ Standard equipment □ Optional equipment ○ Accessories



○ This contemporary roof box in Black with titanium silver side trims has a 520-litre capacity and fits all BMW roof rack systems. It can be opened from both sides and features triple central locking on each side which makes it easy to load and provides anti-theft locking.



○ The universal holder is adjustable in terms of size and is attached to the separately available basic carrier or to the optional equipment "Travel & Comfort". It provides a secure hold for a wide range of Apple or Samsung tablets with BMW safety case from 7" to 11". It can be rotated by 360° and locked in any desired inclination.



○ This innovative vehicle interior mirror incorporates an adaptive universal remote control for up to three garage doors and property gates.

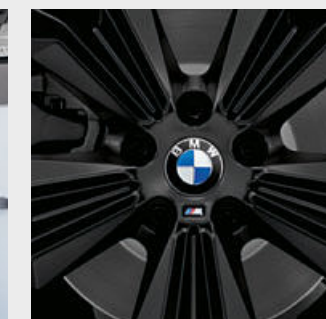

○ The floating hub cap consists of the BMW logo that no longer turns with the wheel but instead remains level.



○ The high-quality 20" M light alloy wheels Double-spoke 717 M are designed in Jet Black matt, weight-optimised with flow forming and with M logo. TPMS summer complete wheel set with run-flat tyres, wheel size 8J x 20 with tyre size 225/40 R20 94Y RSC.

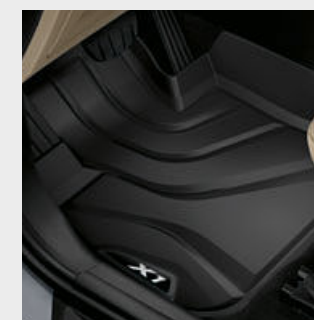

○ Precisely fitting protection against moisture and dirt in the front footwell. Featuring a black design with a stainless steel inlay, they perfectly complement the interior.



○ Anti-slip, water-resistant mat for protecting the luggage compartment from dirt and moisture. In black with stainless steel inlay matching the interior.

Discover the wide range of innovative solutions available for the exterior and interior, communication and information, and for transportation and the luggage compartment. Your BMW Partner is on hand to advise you on the whole range of Original BMW

Accessories and the BMW M Performance Parts product portfolio. For further information, please visit www.bmw.com

BMW X1		sDrive18i	sDrive20i	xDrive20i	xDrive25i	sDrive16d	sDrive18d	xDrive18d	sDrive20d	xDrive20d	xDrive25d	xDrive25e
--------	--	-----------	-----------	-----------	-----------	-----------	-----------	-----------	-----------	-----------	-----------	-----------

Weight												
Unladen weight EU ¹	kg	1480 [1510]	[1570]	[1655]	[1660]	1555 [1575]	1585 [1585-1615]	1660 [1660-1685]	[1630]	[1695]	[1695]	[1820]
Maximum permissible weight	kg	2000 [2025]	[2065]	[2155]	[2160]	2040 [2040]	2090 [2125-2090]	2170 [2190-2170]	[2130]	[2200]	[2180]	[2330]
Permitted load	kg	595 [590]	[570]	[575]	[575]	560 [540]	580 [585-580]	585 [585-580]	[575]	[580]	[560]	[585]
Permitted trailer load, unbraked ²	kg	740 [750]	[750]	[750]	[750]	750 [750]	750 [750]	750 [750]	[750]	[750]	[750]	[750]
Permitted trailer load, braked, max. 12% gradient/max. 8% gradient ²	kg	1700/1700 [1700/1700]	[1800/1800]	[2000/2000]	[2000/2000]	1700/1700 [1700/1700]	1800/1800 [1800/1800]	1800/1800 [1800/1800]	[1800/1800]	[2000/2000]	[2000/2000]	[750/750]
Luggage capacity	l	505-1550	505-1550	505-1550	505-1550	505-1550	505-1550	505-1550	505-1550	505-1550	505-1550	450-1470

BMW TwinPower Turbo engine ³												
Cylinders/valves	-	3/4	4/4	4/4	4/4	3/4	4/4	4/4	4/4	4/4	4/4	3/4
Capacity	cm ³	1499	1998	1998	1998	1496	1995	1995	1995	1995	1995	1499
Max. output/engine speed	kW (hp)/rpm	100 (136)/4500-6500	131 (178)/5000-5500	131 (178)/5000-5500	170 (231)/5000-6000	85 (116)/4000	110-100 (150-136)/4000	110-100 (150-136)/4000	140 (190)/4000	140-120 (190-163)/4000	170 (231)/4400	92 (125) ⁴ /5000-5500
Max. torque/engine speed	Nm/rpm	220/1500-4100	280/1350-4200	280/1350-4200	350/1450-4500	270/1750-2250	350/1750-2500	350/1750-2500	400/1750-2500	400/1750-2500	450/1500-3000	220/1500-3800

eDrive Motor												
Max. output	kW (hp)	-	-	-	-	-	-	-	-	-	-	70 (95)
Max. torque	Nm	-	-	-	-	-	-	-	-	-	-	165
System output	kW (hp)	-	-	-	-	-	-	-	-	-	-	162 (220)
System torque	Nm	-	-	-	-	-	-	-	-	-	-	385

Lithium-ion high-voltage battery												
Battery type/net battery capacity	kWh	-	-	-	-	-	-	-	-	-	-	Li-ion/8.8
Electric range/Maximum total range, combined ⁶	km	-	-	-	-	-	-	-	-	-	-	[57-54/-]
Charging time (AC rapid charging with BMW Wallbox) ⁷	h	-	-	-	-	-	-	-	-	-	-	approx. 3.2

Power transmission												
Type of drive	-	Front-wheel	Front-wheel	All-wheel	All-wheel	Front-wheel	Front-wheel	All-wheel	Front-wheel	All-wheel	All-wheel	Electric all-wheel drive
Standard transmission	-	6-speed manual	7-speed Steptronic with double clutch	8-speed Steptronic	8-speed Steptronic	6-speed manual	6-speed manual	6-speed manual	8-speed Steptronic	8-speed Steptronic	8-speed Steptronic	6-speed Steptronic

Performance												
Top speed	km/h	205 [203]	[226]	[223]	[235]	190 [190]	205-200 [205-200]	204-197 [204-197]	[222]	[219-211]	[235]	[193]
Top electric speed	km/h	-	-	-	-	-	-	-	-	-	-	[135]
Acceleration 0-100 km/h	s	9.7 [9.7]	[7.6]	[7.3]	[6.5]	11.5 [11.5]	9.3-10.0 [9.4-10.1]	9.3-10.0 [9.4-10.2]	[7.9]	[7.8-8.7]	[6.6]	[6.9]

Consumption ^{3,4} - All engines conform to the EU6 standard												
Urban	l/100 km	7.1-7.2 [6.8-7.2]	[7.0-7.5]	[7.6-8.0]	[7.9-8.1]	5.1-5.3 [4.6-4.8]	5.0-5.4 [4.7-5.0]	5.9-6.1 [5.1-5.6]	[5.0-5.5]	[5.3-5.8]	[5.5-5.9]	-
Extra-urban	l/100 km	4.8-5.3 [4.8-5.2]	[5.0-5.4]	[5.5-5.9]	[5.6-6.1]	4.1-4.5 [3.9-4.1]	4.2-4.5 [4.3-4.7]	4.6-5.0 [4.6-5.0]	[4.3-4.6]	[4.8-5.0]	[4.5-4.8]	-
Combined	l/100 km	5.6-6.0 [5.6-5.9]	[5.8-6.1]	[6.3-6.7]	[6.5-6.8]	4.5-4.8 [4.1-4.4]	4.5-4.8 [4.4-4.8]	5.0-5.4 [4.8-5.2]	[4.6-4.9]	[5.0-5.3]	[4.9-5.2]	[1.9-2.1]
Consumption range, combined	kWh/100 km	-	-	-	-	-	-	-	-	-	-	[13.8-14.3]

BMW X1		sDrive18i	sDrive20i	xDrive20i	xDrive25i	sDrive16d	sDrive18d	xDrive18d	sDrive20d	xDrive20d	xDrive25d	xDrive25e
--------	--	-----------	-----------	-----------	-----------	-----------	-----------	-----------	-----------	-----------	-----------	-----------

Exhaust emissions standard (type-certified)	-	EU6d	EU6d	EU6d	EU6d	EU6d	EU6d	EU6d	EU6d	EU6d	EU6d	EU6d
Combined CO ₂ emissions	g/km	129-138 [127-136]	[132-141]	[144-153]	[148-157]	117-126 [109-115]	118-127 [117-126]	133-142 [128-137]	[121-130]	[131-140]	[128-135]	[43-48]
Tank capacity, approx.	l	51	51	61	61	51	51	51	51	51	51	36

Wheels/tyres												
Tyre dimensions		225/55 R17 W	225/55 R17 W	225/55 R17 W	225/55 R17 W	225/55 R17 W	225/55 R17 W	225/55 R17 W	225/55 R17 W	225/55 R17 W	225/55 R17 W	225/55 R17 W
Wheel size		7.5J x 17	7.5J x 17	7.5J x 17	7.5J x 17	7.5J x 17	7.5J x 17	7.5J x 17	7.5J x 17	7.5J x 17	7.5J x 17	7.5J x 17
Material		Light alloy	Light alloy	Light alloy	Light alloy	Light alloy	Light alloy	Light alloy	Light alloy	Light alloy	Light alloy	Light alloy

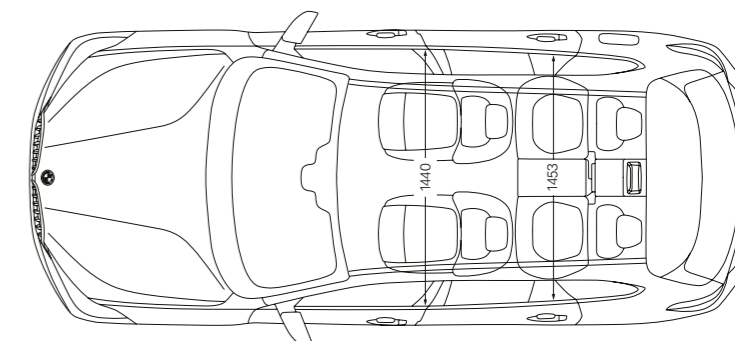
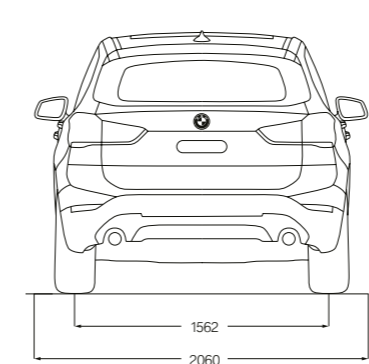
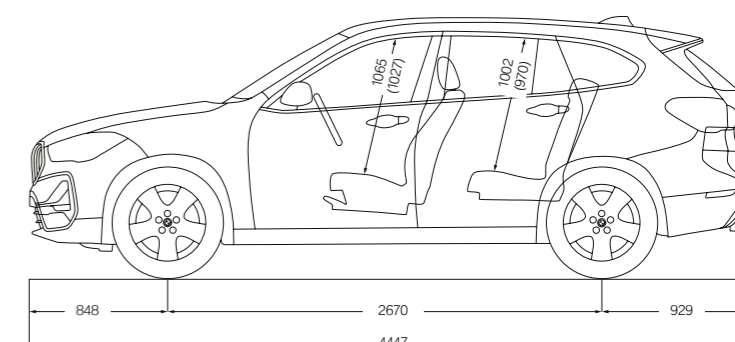
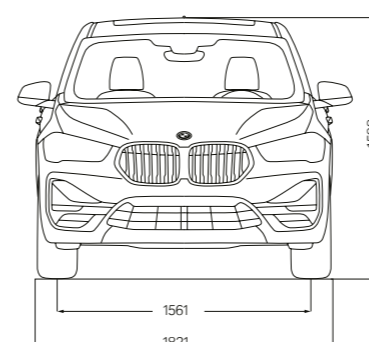

The figures for performance, fuel consumption and CO₂ emissions refer to vehicles with standard transmission. Figures in [] are for vehicles with Steptronic transmission.

¹ The EC unladen weight refers to a vehicle with standard equipment and does not include any optional extras. The unladen weight includes a 90% full tank and a driver weight of 75 kg. Optional equipment may affect the weight of the vehicle, the payload and the top speed if the selected equipment has an impact on the vehicle's aerodynamics.

² The actual total weight of the trailer must not exceed the maximum trailer load, taking into account the maximum tow bar download.

³ Performance data of petrol engines apply to vehicles using RON 98 fuel. Fuel consumption data apply to vehicles using reference fuels in accordance with EU Regulation 2007/15. Unleaded RON 91 and higher with a maximum ethanol content of 10% (E10) may also be used. BMW recommends RON 95 super unleaded petrol.

⁴ The official data for fuel consumption and CO₂ emissions were determined in accordance with the measurement processes as defined by European Regulation (EC) 715/2007 in the applicable version. The ranges take into account differences in the selected wheel and tyre size. Figures have been determined on the basis of the new WLTP test cycle and have been converted back into NEDC figures for comparability. Values other than those specified here may apply for the assessment of taxes and other vehicle-related charges that are (also) based on CO₂ emissions.

⁵ Provisional figures; any missing figures were unavailable at the time of publication.

⁶ Range depends on the equipment and various factors. In particular: personal driving style, route characteristics, exterior temperature, heating/air conditioning, pre-conditioning and the chosen equipment.

⁷ Dependent on the local electricity infrastructure. Charging time corresponds to a 100% charge of maximum capacity.

⁸ Depending on the environmental conditions, a temporary peak performance is provided, which can be approx. 10% higher than the rated output. Peak performance duration increases with decreasing ambient temperature (at +25°C approx. 5 s, at -20°C approx. 40 s).



YOUR NEW SPEED DATING APP.

DOWNLOAD NOW THE BMW BROCHURES APP FROM YOUR APP STORE AND DISCOVER DRIVING PLEASURE!

BMW X1 xDRIVE20i WITH xLINE:

BMW TwinPower Turbo 4-cylinder petrol engine, 131 kW (178 hp), 19" light alloy wheels Y-spoke style 580 Bicolour, exterior colour in BMW Individual Storm Bay metallic, Sport seats in leather 'Dakota' with perforations Oyster/Grey highlight, interior trim finishers in fine-wood trim oak grain matt with highlight trim finisher Pearl Chrome.

The models illustrated in this medium show the equipment and configuration options (standard and optional) for vehicles produced by BMW AG for the German market. Alterations in standard and optional equipment and the configurations available for the different models, as described in this medium, may occur after 11/11/2020, the editorial deadline for this medium, or according to the specific requirements of other member states of the European Union. Your local BMW Partner is available to provide further details. Subject to change in design and equipment.

Of course, each vehicle is designed for economical recycling after its long-running life. You can find more information regarding your end-of-life vehicle on our website www.bmw.de/recycling
© BMW AG, Munich, Germany. Not to be reproduced wholly or in part without prior written permission of BMW AG, Munich.